

Power Supplies

- 6V Daughterboard Power (<1A)
- 3.3VAN LTC2284 (200mA), AD9777 (<500mA)
- 3.3VCLK AD9510 (<500mA), CLOCK (88mA)
- 3.3VDIG All IO (<2A)
- 2.5V FPGA AUX (<100mA), Ethernet Core (<300mA), SERDES (<150mA)
- 1.8V Ethernet Core (~500mA)
- 1.2V FPGA Core (<2A)

Front Panel Power

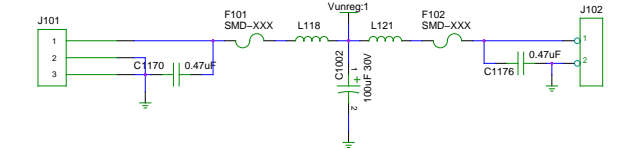

ALT Power

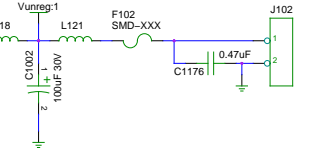

FAN Power

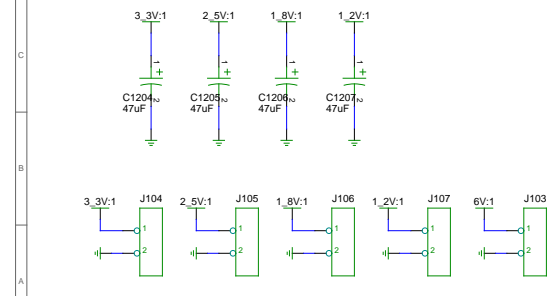
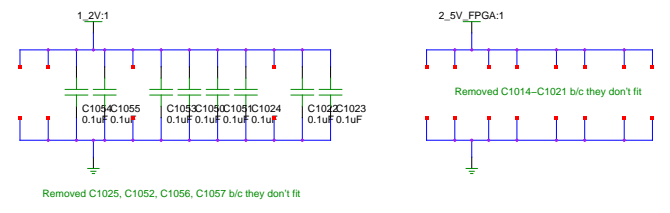
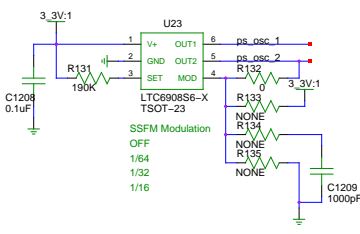
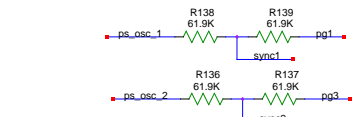
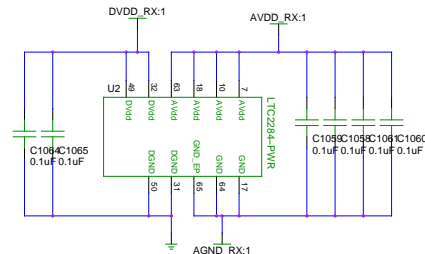
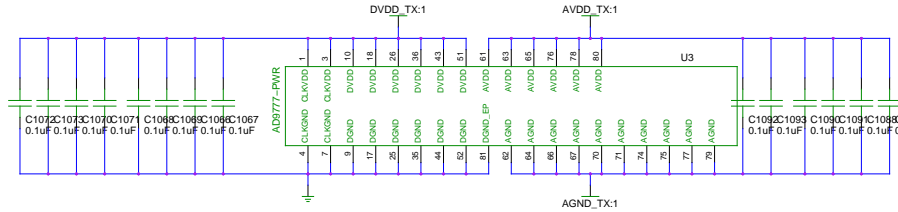
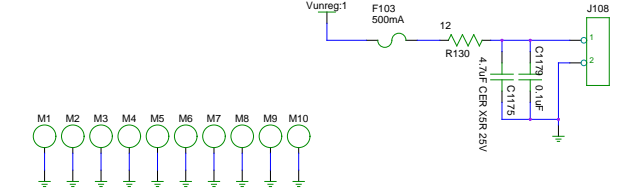

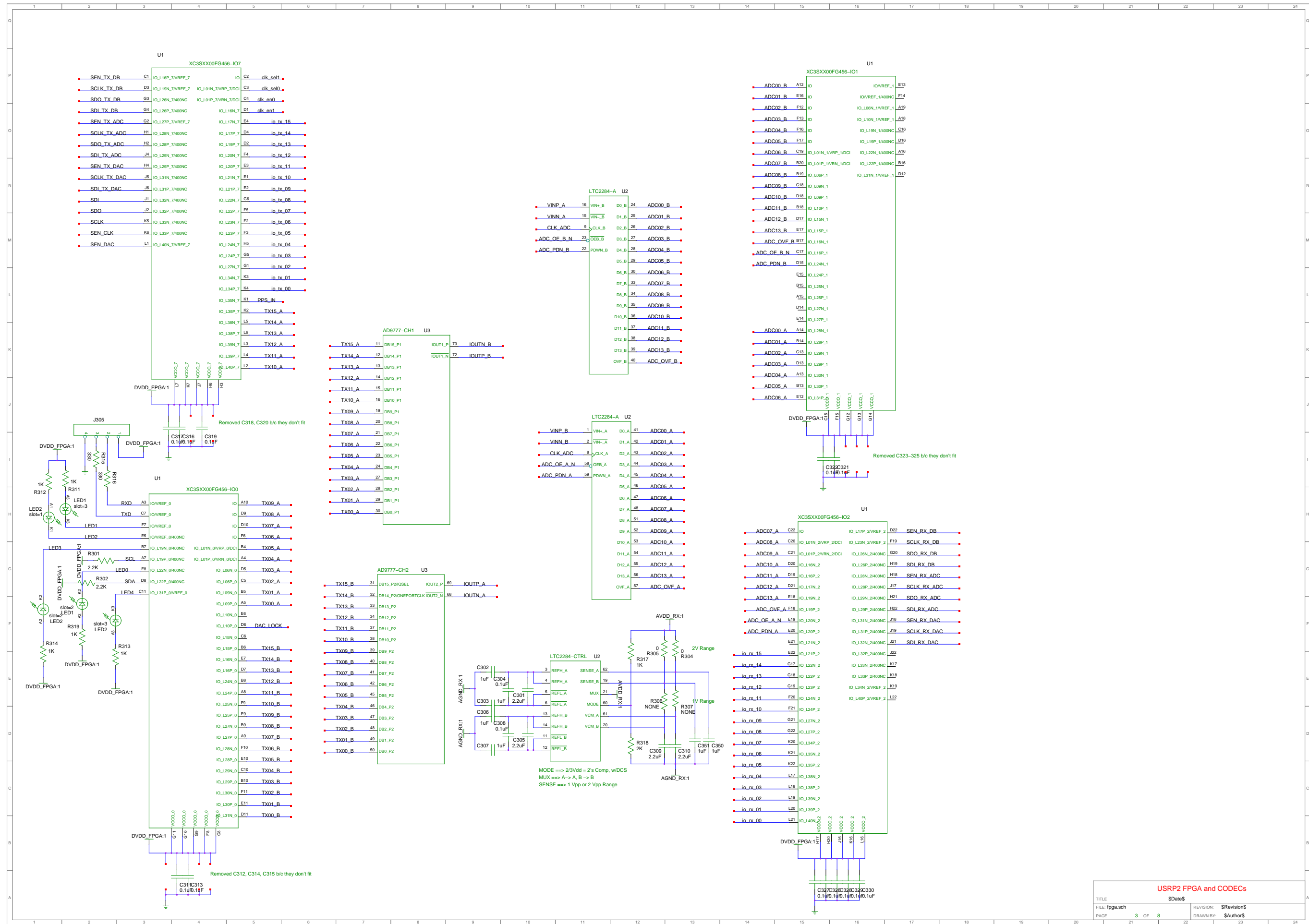

Both JTAG ports are 2.5V

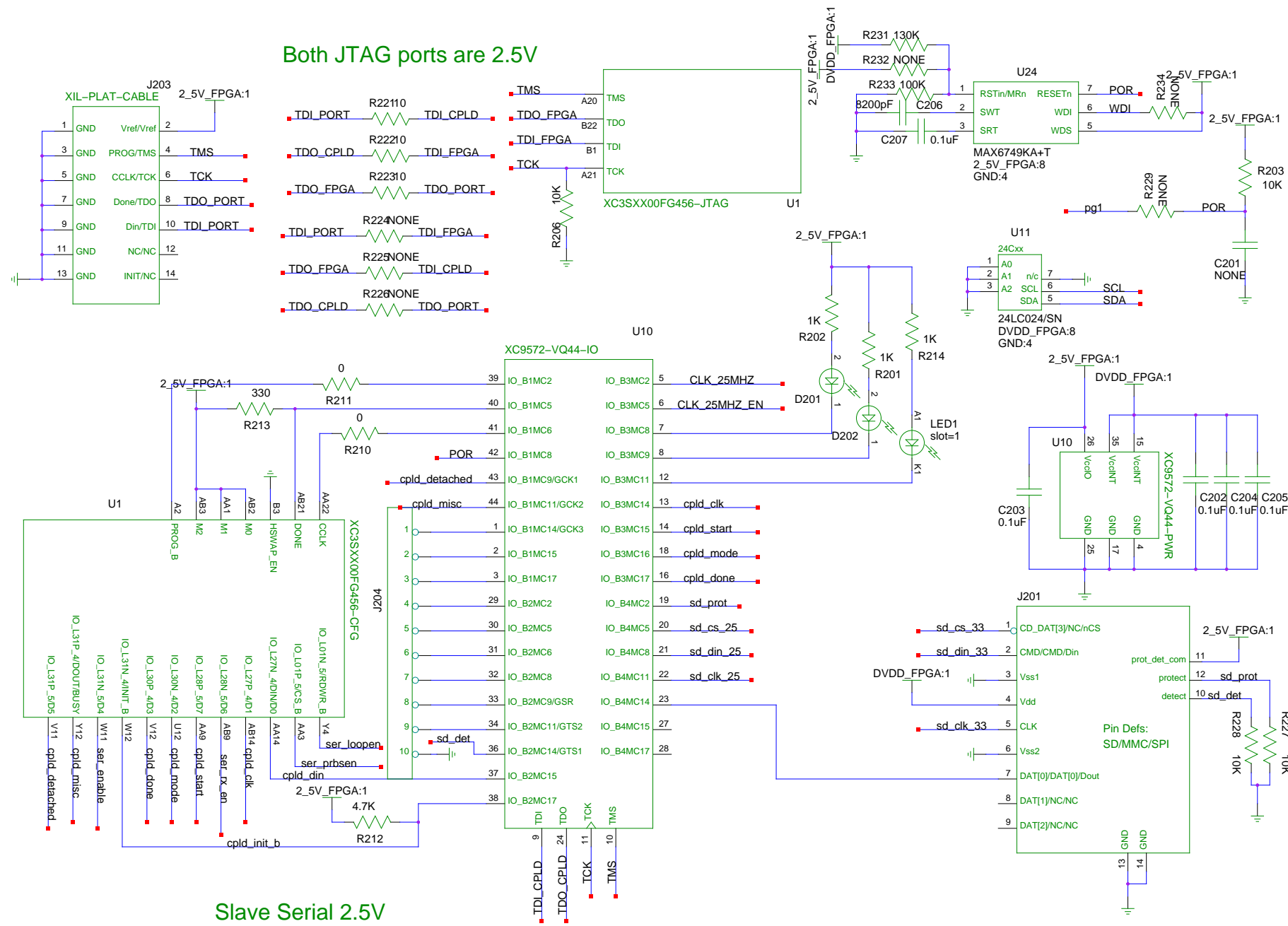

Slave Serial 2.5V
Bank 4 must be 2.5V

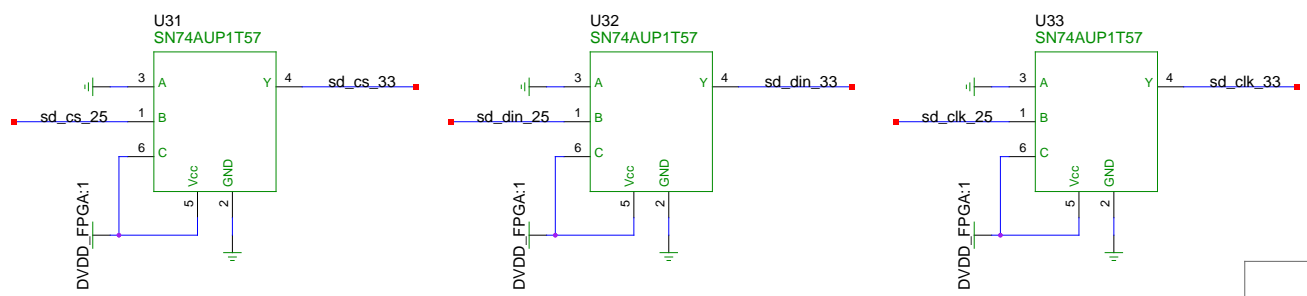

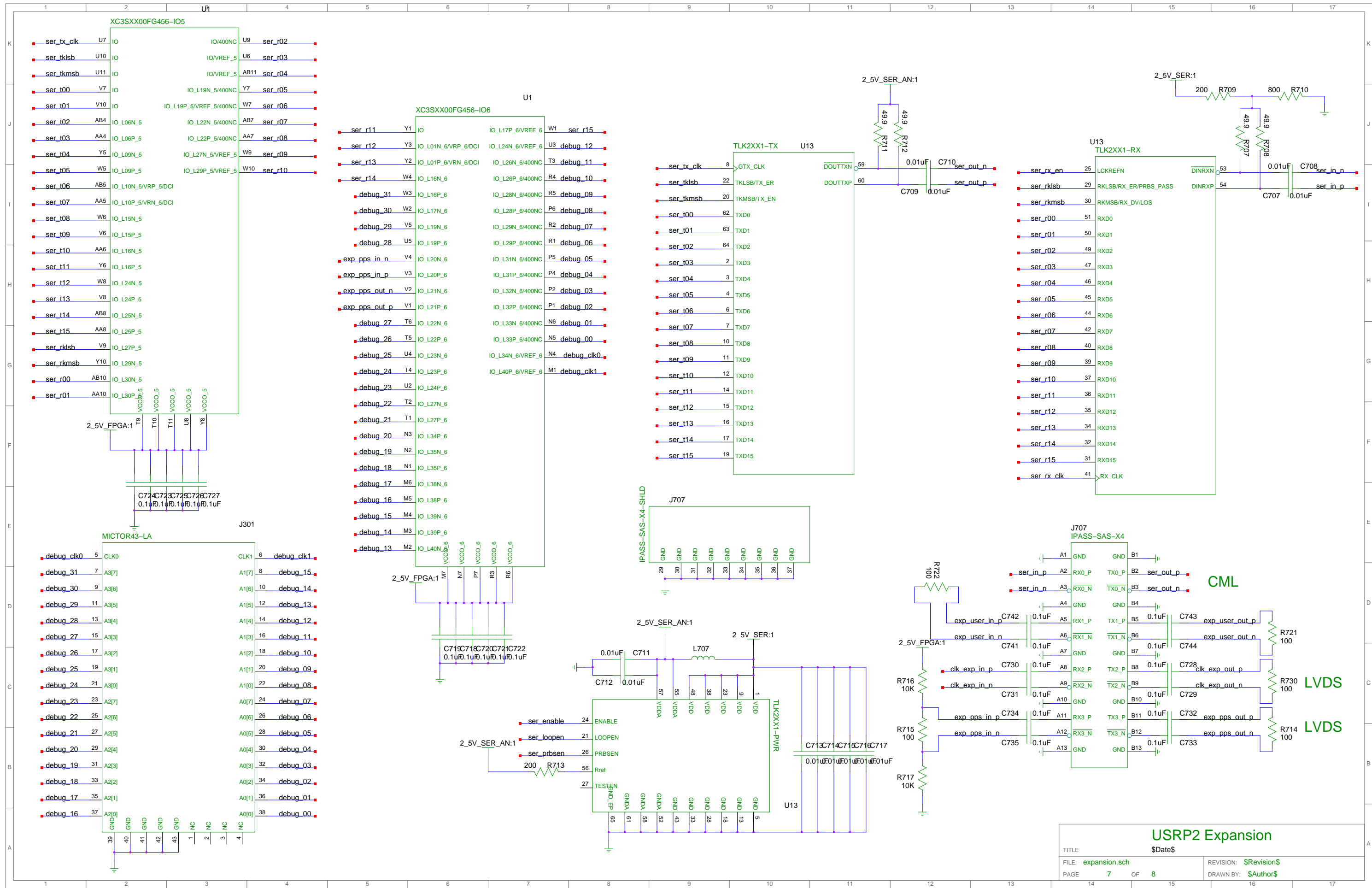

TITLE		\$Date\$	
FILE:	expansion.sch	REVISION:	\$Revision\$
PAGE:	7 OF 8	DRAWN BY:	\$Author\$

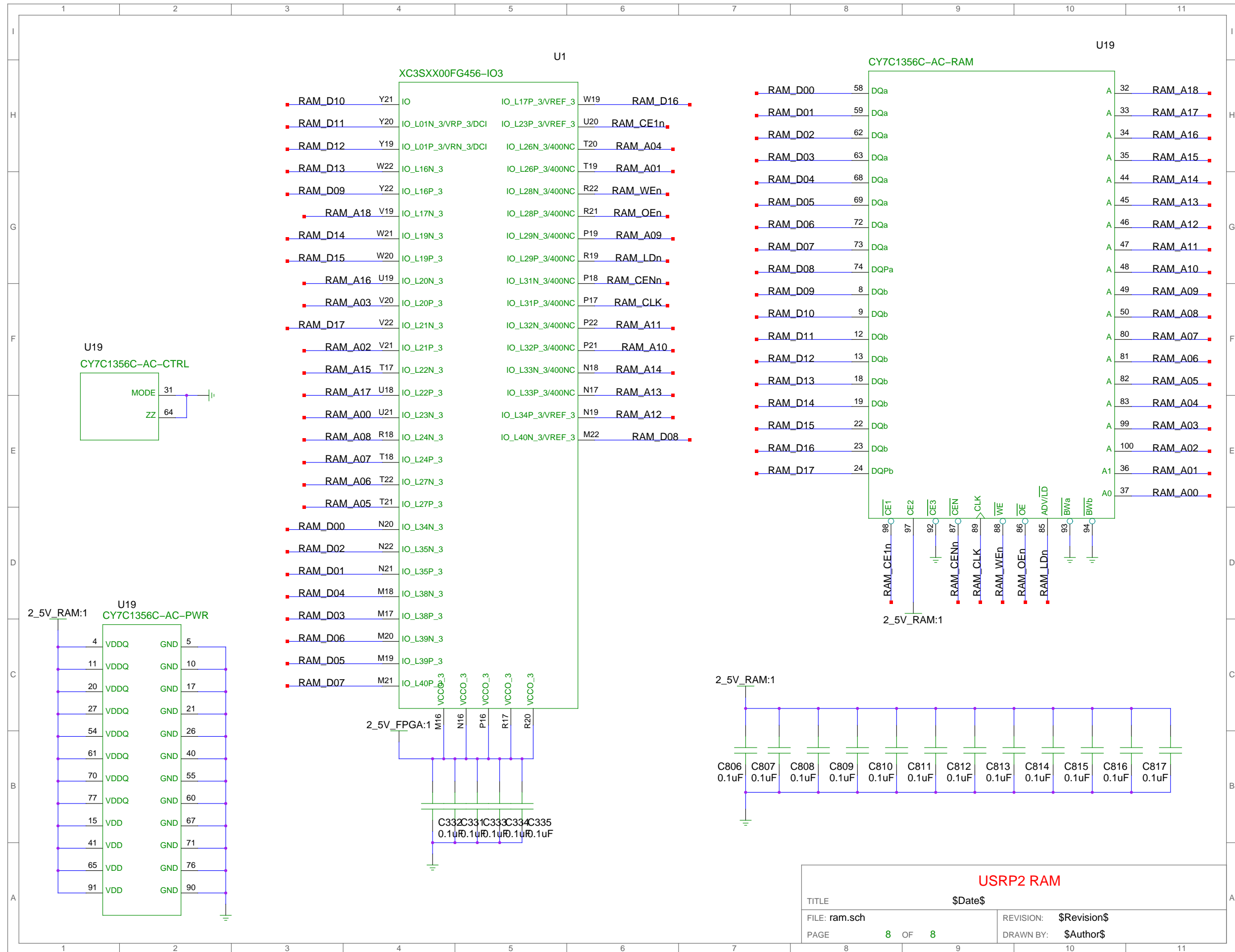

USRP2 RAM		
TITLE	\$Date\$	
FILE: ram.sch	REVISION:	\$Revision\$
PAGE 8 OF 8	DRAWN BY:	\$Author\$